

**Guidance Notes on**

# **Factories and Industrial Undertakings (Noise at Work) Regulation**

**This Guidance Notes is prepared by the  
Occupational Safety and Health Branch of the  
Labour Department**

---

**This edition            December 2017**

**This Guidance Notes is issued free of charge and can be obtained from offices of the Occupational Safety and Health Branch, Labour Department. It can also be downloaded from <http://www.labour.gov.hk/eng/public/os/C/FIUNR.pdf>. For enquiries about addresses and telephone numbers of the offices, please call 2559 2297.**

**It may be freely reproduced except for advertising, endorsement or commercial purposes. Please acknowledge the source as ‘Guidance Notes on Factories and Industrial Undertakings (Noise at Work) Regulation’, published by the Labour Department.**

## Guidance Notes on

# Factories and Industrial Undertakings (Noise at Work) Regulation

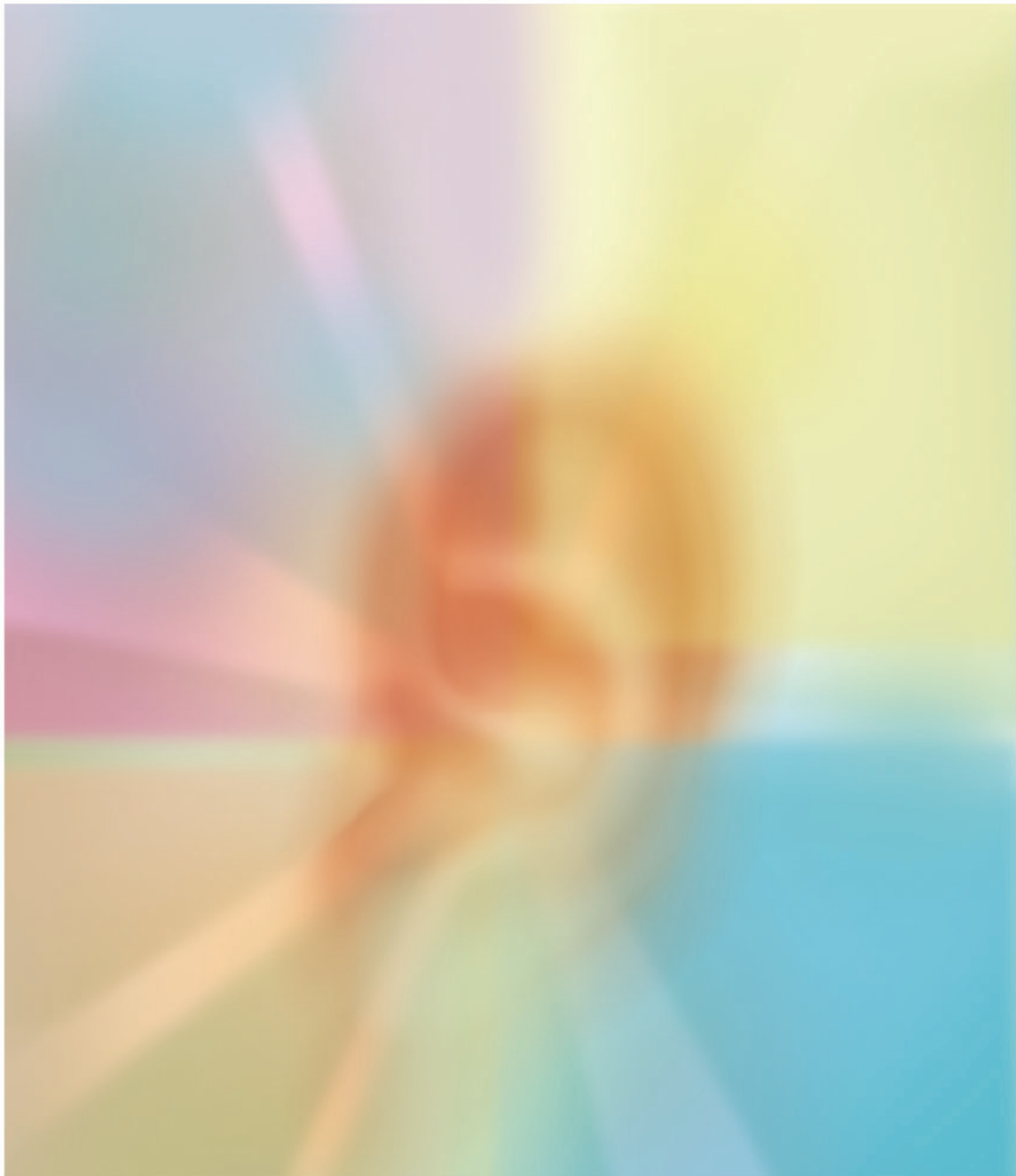

## CONTENTS

	Page
Introduction	3
Section 2 — Interpretation	4
Section 3 — Assessment of Noise Exposure	5
Section 4 — Ear Protection Zones	8
Section 5 — Specification of Distance for Noisy Machines or Tools	9
Section 6 — Ear Protection	10
Section 7 — Approval of Ear Protectors	12
Section 8 — Reduction of Noise Exposure	12
Section 9 — Maintenance and Use of Equipment	15
Section 10 — Provision of Information to Employees	17
Section 11 — Exemption	18
Section 12 — Offences	18
Appendix 1 — List of Common Noisy Machinery	19
Appendix 2 — Guide on Equipment and Procedures for Noise Assessment in Working Environments	20
Appendix 3 — Noise Assessment Report	29
Appendix 4 — Guide on Types and Selection of Suitable Ear Protectors	30
Appendix 5 — Guide on Industrial Noise Control	40
Enquiries and Complaints	45

## Introduction

1. Noise may be defined as sound undesired by the recipient. Besides being a nuisance, noise may interfere with working efficiency, by hindering communication between employees; it may also be a cause of accidents, by masking warning signals; but most importantly, it may damage our hearing.
2. Excessive noise can result in permanent hearing damage. Short exposure to extremely loud noise, such as an explosion, can result in instant deafness through rupture of the ear drum. In contrast, regular exposure to high noise levels over a long period of time may result in destruction of certain inner ear cells and a loss of hearing which is permanent and incurable.
3. Sound is produced by pressure changes in the ear. The unit of sound pressure is pascal (Pa). Since the range of sound pressures encountered in noise control work is very wide, it is convenient to employ sound pressure level (SPL) which is defined as:

$$\text{SPL} = 20 \log_{10} \left( \frac{P}{P_0} \right) \text{ dB}$$

where

$P$  = the sound pressure in Pa

$P_0$  = reference sound pressure of  $2 \times 10^{-5}$  Pa

Pa = Newton/metre<sup>2</sup>

dB = decibel

Hence when  $P = 200$  Pa (peak action level),

$$\text{SPL} = 20 \log_{10} \left( \frac{200}{2 \times 10^{-5}} \right)$$

$$= 20 \times 7$$

$$= 140 \text{ dB}$$

4. The apparent loudness that we attribute to a sound varies not only with the sound pressure but also with the frequency. This effect is taken into account by 'weighting networks' designated as A, B, C, etc. For industrial noise measurement, frequency A-weighting network is used as it corresponds to the frequency response of the human ear and also has a good correlation to the risk of noise-induced hearing loss (NIHL). Measurement of noise levels are expressed in 'decibels weighted on the A-scale' of dB(A).
5. The Factories and Industrial Undertakings (Noise at Work) Regulation provides for the requirements on protection of hearing of employees in industrial undertakings. This Guidance Notes other than explaining the main provisions of the Regulation in simple language, it affords technical guidance for proprietors to discharge their legal obligations. Whilst every care has been taken in the preparation of this guide, the Regulation remains to be the sole authority of the provisions of the law explained.

## Section 2—Interpretation

6. There are three action levels of noise defined in Section 2:
  - (a) “First action level”—a daily personal noise exposure ( $L_{EP,d}$ ) of 85 dB(A)
  - (b) “Second action level”—a daily personal noise exposure ( $L_{EP,d}$ ) of 90 dB(A)
  - (c) “Peak action level”—a peak sound pressure level of 140 dB or peak sound pressure of 200 Pa.
7. The formal mathematical definition of  $L_{EP,d}$ , expressed in dB (A), is:

$$L_{EP,d} = 10 \log_{10} \left\{ \frac{1}{T_o} \int_0^{T_e} \left[ \frac{P_A(t)}{P_o} \right]^2 dt \right\}$$

where  $T_o$  = 8 hours or 28,800 seconds

$T_e$  = the duration of the person’s personal exposure to sound

$P_o$  = 20  $\mu$ Pa

$P_A(t)$  = the time-varying value of A-weighted instantaneous sound pressure in pascals in the undisturbed field in air at the atmospheric pressure to which the person is exposed (in the locations occupied during the work day), or the pressure of the disturbed field adjacent to the person’s head adjusted to provide a notional equivalent undisturbed field pressure.

8. Generally,  $L_{EP,d}$  can be regarded as the total exposure to noise throughout the working day, taking account of the average noise levels in working areas and the time spent in them, but taking no account of the effect of any ear protectors worn. In practical situation, the  $L_{EP,d}$  values can be readily obtained by using integrating sound level meters or noise dosimeters complying with recognised standards. The equation in paragraph 7 need not be used.
9. The peak pressure is the highest pressure reached by the sound wave, for example the peak pressure of the sound impulse generated by a cartridge-operated fixing tool.
10. The Regulation requires the proprietor to take certain basic steps where an employee is likely to be exposed to noise at or above the first action level. These, together with additional action, must also be taken where an employee is likely to be exposed at or above the second or peak action level.
11. In practice, action will usually be determined by the average noise level over the working day, from which the value of  $L_{EP,d}$  can be determined, except where employees are exposed to infrequent but loud impact or explosive noise, e.g. from cartridge-operated fixing tools, which might cause the peak action level to be exceeded even though  $L_{EP,d}$  is below the second action level.
12. Where it is difficult or impracticable to establish  $L_{EP,d}$  for the whole working day, it might be necessary to base action on the noise over some shorter sampling period or the area noise level of the workplace (see paragraphs 21 & 22).

## Section 3 – Assessment of Noise Exposure

13. The first step of a hearing conservation programme is to measure and evaluate the noise. Section 3(1) requires proprietor to arrange for a noise assessment wherever an employee is likely to be exposed at or above the first or peak action level. The assessment will need to:
  - (a) identify all employees likely to be so exposed; and
  - (b) provide enough information to enable appropriate action to be taken.

### Deciding whether an assessment is needed

14. A preliminary decision on whether an assessment is needed can usually be reached without making detailed noise measurements.
15. As a rough guide, the first action level might be reached and an assessment of  $L_{EP,d}$  will usually be needed wherever people have to shout to be heard or have difficulty being heard clearly by someone about 2 metres away, or they find it difficult to talk to each other. If some measurements of the noise in a few representative places suggest that any employee might be exposed to the first action level or more, it will be necessary to go on to a more comprehensive assessment.
16. As a result of a comprehensive noise survey across the industry, the Labour Department has drawn up a list of noisy machinery which normally will emit noise exceeding the first action level. A noise assessment is usually required when such noisy machinery is installed. A list of such machinery is given in Appendix 1.
17. Assessments of peak sound pressure are most likely to be needed where employees are exposed to loud explosive noises, such as cartridge-operated fixing tools. They might also be needed where there are high levels of impact noise, such as from heavy hammering on metal.

### Assessment

18. An assessment will be adequate if it meets the objectives set out above. It will need to be based on reliable information about work patterns and noise levels, so the affected employees should be consulted; this will also help ensure their co-operation with any control measures that might turn out to be needed.
19. An adequate assessment can usually be made without making a detailed measurement of each employee's exposure, for example:
  - (a) where groups of employees are employed in an area throughout which the noise level is reasonably uniform, the assessment might be based on noise levels measured in the working area and the length of the time that employees are likely to spend there;
  - (b) where groups of employees perform similar tasks, sample measurements on a group of activity basis might be adequate provided that it is representative of individuals within the group;

- (c) sometimes a calculated noise exposure will be adequate if sufficient information is available about the noise the machines produce during operation, and the nature and duration of tasks carried out by the employees. For example, where employees use noisy portable tools it may be possible to measure the noise level in typical jobs and assess the exposure produced by different patterns of use.
20. Detailed advice on noise surveys is given in Appendix 2: Equipment and procedures for noise assessments in working environments.

### Variable exposure to noise

21. Some employees are exposed to noise levels which vary considerably either during the day or from one day to another, for example because they visit a number of noisy areas, or because they do a variety of jobs requiring intermittent use of noisy tools and machines. Sometimes it will be impracticable, or of little use, to make an accurate measurement of  $L_{EP,d}$  for these persons.
22. In these circumstances, the best course will be usually to treat all working areas where the average noise level (or 'equivalent continuous sound level',  $L_{eq}$ ) is 85 or 90 dB(A) or more as places where the corresponding action levels are likely to be exceeded (see also paragraphs 45 & 54), until a better assessment can be made.

### Review of assessments

23. Section 3(2) requires the proprietor to ensure that the noise assessment is kept up-to-date and adequate for the purposes of noise control and hearing protection programmes. A new assessment should be made whenever there is a significant change in the work to which the assessment relates or where the proprietor has reason to believe that the assessment is no longer valid. Changes that might create the need for a review include:
- (a) installation or removal of machinery;
  - (b) substantial changes in workload, work pattern, or machine speeds;
  - (c) changes in building structure or machine layout;
  - (d) machine wear or general deterioration;
  - (e) modifications to machinery and introduction of automation; and
  - (f) the noise control programme (such as change in control equipment).
24. Even where there have been no obvious changes, workplaces should not be left for long periods without checking to discover whether there is in fact any need for a review, for example because of a gradual increase in noise level due to machine wear. Spot checks can be made by establishing a few selected locations where the noise is measured periodically such as places where exposure is high or a gradual increase is likely. The interval between checks will depend on local circumstances, but for most kinds of machinery the maximum would be about 2 years (see also paragraphs 66 & 67).



## Competent persons

25. Noise assessments have to be made by a person who, by reason of his training and experience, is competent to carry out such assessments meeting the objectives in paragraph 13.
26. The competent person will need to be capable of not only measuring noise but of bringing together and presenting enough information about the noise exposure to enable the proprietor to make correct decisions on what should be done to comply with the Regulation, or of advising on whether additional specialist support is needed. Knowledge alone will not be sufficient; the person should possess experience and skill appropriate to the situations to be handled. He/she should know:
  - (a) the purpose of the assessment;
  - (b) his/her own limitations, whether of knowledge, experience, facilities or resources;
  - (c) how to record results and explain them to others;
  - (d) the reasons for using various kinds of instrument and their limitations; and
  - (e) how to interpret information provided by others, for example, on the noise generated by tools and the jobs done with them, to calculate probable exposures.
27. The level of expertise needed will depend largely on the complexity of the situation to be assessed. Where employees are regularly exposed to steady noise throughout the working day (for example in a weaving shed), or to intermittent but regular periods of steady noise, the task is straightforward and requires little beyond the ability to handle simple instruments and to relate their readings to the requirements of the Regulation. Those who are to assess irregular exposures, or situations where employees intermittently use a variety of different machines will need a better understanding of techniques.
28. The ability to understand relevant guidance to make an assessment meeting the objectives in paragraph 13 is more important than formal qualifications. Many engineers, scientists and other technical staff will have gained sufficient skill to carry out a proper assessment through practical experience of making noise measurements and using the results. Some will, however, need further training. They may obtain the necessary training by attending courses in the Occupational Safety and Health Council (OSHC).

29. Graduates of the following courses are considered competent to carry out noise assessments:
- (a) Occupational Safety and Health Council Certificate of Competence in Workplace Noise Assessment Course
  - (b) Hong Kong Polytechnic Associateship in Noise and Vibration Control Course
  - (c) Hong Kong Polytechnic Post-experience Diploma in Noise and Vibration Control Course
  - (d) Hong Kong Polytechnic Certificate of Proficiency in Industrial Safety Course
  - (e) Hong Kong Polytechnic Post-experience Certificate in Industrial Safety Course
  - (f) Hong Kong Polytechnic Certificate of Proficiency in Advanced Industrial Safety Course
  - (g) Hong Kong Polytechnic Post-experience Certificate in Advanced Industrial Safety Course
  - (h) The Hong Kong Polytechnic University Post-experience Certificate in Industrial Safety Course
  - (i) The Hong Kong Polytechnic University Post-experience Certificate in Advanced Industrial Safety Course
  - (j) Construction Industry Training Authority Construction Safety Officer Course
  - (k) The Chinese University of Hong Kong Diploma in Occupational Hygiene Course

### **Noise Assessment Report**

30. Section 3(3) requires the competent person after carrying out an assessment to complete an assessment report in a form specified by the Labour Department. A copy of the form is given in Appendix 3.
31. Section 3(4) requires the proprietor to send a copy of the assessment report to the Labour Department within 28 days after completing an assessment.
32. Section 3(5) requires the proprietor to make sure that the appropriate assessment report is kept and readily available for inspection by an Occupational Safety Officer.

### **Section 4–Ear Protection Zones**

33. ‘Ear protection zone’ means any part of an industrial undertaking where the employees are likely to be exposed to the second action level or above or to the peak action level or above. Wherever practicable, the proprietor has to mark ear protection zones with signs showing that they are areas where suitable approved ear protectors must be worn (Fig. 1). The signs need to be located at all entrances to the zones, with repetition as necessary within them. The proprietor has to ensure as far as is practicable that all who enters or remains in these zones wear suitable approved ear protectors. With clear demarcation, the invisible noise hazards will become "visible", making proprietors and employees more aware of the need to take preventive measures.
34. This Section does not apply to industrial undertakings where it is not practicable to mark ear protection zone.

# EAR PROTECTION ZONE

## 聽覺保護區



# WEAR SUITABLE APPROVED EAR PROTECTOR

## 佩戴適合的認可聽覺保護器

Fig. 1 Sign for alerting that approved ear protector must be worn

### Section 5—Specification of Distance for Noisy Machines or Tools

35. When employees are exposed to hazardous machinery noise but where it is not practicable to demarcate ear protection zones, such as on construction sites or where the noisy machine or tool is moved about frequently from time to time (other than inside a demarcated ear protection zone), the proprietor is required to:

- (a) appoint a competent person to carry out a noise assessment to specify a distance within which an employee is at risk of damage to his hearing unless a suitable approved ear protector is worn;
  - (b) attach a sign or label to the machine or tool requiring that a suitable approved ear protector be worn by every employee who operates or assists in the operation of the machine or tool within the specified distance; and
  - (c) ensure that every employee mentioned in sub-paragraph (b) wears suitable approved ear protector.
36. The distance so specified by the competent person will be determined by the sound level of the machine and the exposure time. Again with clear labelling, the invisible noise hazards will become visible, facilitating control. For example, a portable pneumatic concrete breaker is operated by one employee and assisted by another on a construction site. The  $L_{Aeq,T}$  of the operator is measured to be 103 dB(A) and the operating time is about 2 hours. Then the distance to be specified by the competent person will be the distance where the measured  $L_{Aeq,T}$  is 96 dB(A) which is equivalent to 90 dB(A)  $L_{eq,8h}$  (second action level) and is the hearing damage risk criterion.

## Section 6– Ear Protection

37. Wearing suitable ear protectors may be considered as the most common noise control measure and Section 6 deals with the provision of good quality ear protection.

### The need for ear protectors

38. The proprietor's duty to provide suitable approved ear protectors depends on the exposure level:

- (a) *Between first and second action levels*

Where employees are exposed between the first and second action levels, Section 6(1) requires the proprietor to provide suitable approved ear protectors to employees who request for them.

- (b) *Second and peak action levels*

Section 6(3) requires the proprietor to provide suitable approved ear protectors to all employees likely to be exposed at or above the second or peak action levels.

Note: Under Section 9(1)(a), the proprietor has to ensure these ear protectors are properly used.

39. The proprietor will have to ensure that the required ear protectors are provided as far as is practicable. This means he will need to make sure that the arrangements for their selection and issue follow good practice, as outlined below.

## Choosing a suitable type of ear protector

40. Only those ear protectors approved by the Commissioner for Labour under Section 7 can be used. To ensure that they are suitable for the conditions where they will be used and are efficient in providing protection, attention should be paid to:
  - (a) The level and nature of the noise exposure: The 'assumed protection' (defined in Appendix 4: Guide on Types and Selection of Suitable Ear Protectors) should be at least 5 dB(A) or the amount by which the exposure exceeds the second or peak action levels, whichever is the greater.
  - (b) The job and working environment: These can affect comfort, hygiene, etc.
  - (c) Compatibility with any other protective equipment or special clothing worn.
  - (d) The fit to the wearer. AND
  - (e) Any difficulty or discomfort experienced by the wearer.
41. Detailed advice on types of ear protector and their selection is given in Appendix 4.

## Arrangements for the issue of ear protectors

42. The arrangements for issuing suitable approved ear protectors will need to include:
  - (a) The provision of information on why they are being issued, where they should be used, how replacements can be obtained and the proper way to wear and look after them (see under Sections 4, 5 & 9).
  - (b) Measures to ensure that employees can readily obtain ear protectors and replacements when they need them. Such might include personal issue to the individual employee. Personal issue of ear plugs should normally be arranged for obvious hygiene reason. If ear muffs need to be re-used, they should be adequately cleaned and disinfected first. Alternatively, dispensers from which employees can take disposable ear protectors as they need them might be used. The dispensers will need to be so located that the employees can conveniently use them and be kept topped up.
  - (c) Personal choice where this can be reasonably be arranged. Individuals differ in what they find comfortable, so, wherever possible, users should be given a personal choice of ear protector. The proprietor will need to make sure the choice is made from suitable and efficient types.
43. Before ear plugs are first issued, the user should be asked whether he or she has any ear trouble, such as irritation of the ear canal, earache, discharging ears, or is under treatment for any ear disease. Persons who report such troubles should be referred to a doctor for an opinion on whether they may use the devices with safety.

44. Some people tend to speak quietly when they are wearing ear protectors in noisy areas because they can hear their own voice more clearly, and instinctively lower its volume. This can cause communication problems, so the user should be advised to remember to speak up when wearing the ear protectors. Some users tend to remove ear protectors when speaking to others in noisy areas – it should be explained to them that once they are used to the situation, communication will be easier with ear protectors than without them.

### **Employees with variable noise exposure**

45. The proprietor should make sure that his/her employee has suitable ear protectors adequate for the worst situation likely to be encountered and knows when and where to use them (see also paragraphs 21 & 22).

### **Exemption**

46. Section 6(2) provides an exemption from requiring a proprietor to provide a suitable approved ear protector to his/her employee who is exposed between the first and second action levels where use of ear protector might cause risk to the safety of the employee or of any other person, for example, by making warning sound less noticeable, such as when driving a truck on a construction site.

## **Section 7 – Approval of Ear Protectors**

47. Ear protectors provided with reasonable noise attenuation data will be approved by the Commissioner for Labour. For the purpose of this Regulation, only approved ear protectors can be used. Up to now, more than 290 types of ear protectors are suitable for approval. The list of approved ear protectors can be found in the website of the Department at <http://www.labour.gov.hk/eng/faq/oshq9.html>. It is important to note that not every approved ear protector is suitable for all situation in noisy working environment. Detailed advice on the selection and types of ear protector is given in paragraph 40 and Appendix 4.

## **Section 8 – Reduction of Noise Exposure**

### **Programme of measures**

48. Where employees are exposed at or above the first or peak action levels, the proprietor will have to reduce exposure as far as is practicable by means other than the provision of approved ear protectors. To achieve this, the proprietor will need to implement a programme of control measures.

Where adequate reduction is not practicable in the short term, the programme should continue to operate as long as necessary, and should include regular reviews of the feasibility of further noise reduction, taking account of the development in noise control techniques.

49. The most reliable way of limiting exposure is to reduce the noise level itself. An effective programme will:
  - (a) identify the noise sources;
  - (b) identify practicable steps to reduce noise level by engineering means;
  - (c) establish priorities for action;
  - (d) ensure that action is taken; and
  - (e) reassess noise exposure.
50. In establishing priorities, the aim should be to identify where action will bring most benefit. In general, higher priority should be given to the more cost-effective measures. Factors to take into account are:
  - (a) the number of people who would benefit from the noise reduction measures;
  - (b) the noise exposure levels involved;
  - (c) the likelihood that engineering effort will produce worthwhile results; and
  - (d) any factors which make reliance on personal ear protection especially undesirable, such as strenuous work in a hot, dirty environment.
51. Programme to control noise by engineering means will only be effective if the staff working on them are competent in noise control engineering, or are advised by someone who is. Sometimes, however, the noise can be obviated by more fundamental changes, such as using a different, quieter process. Here, knowledge of the process and alternative ways of doing the job may be more important.
52. There are many ways of reducing noise; no single technique will be correct for every situation. Some of the measures that should be considered are outlined in Appendix 5: Industrial noise control. Reference should be made to the literature on noise control engineering for more detailed information on techniques. Any successful engineering programme will include a systematic approach to identifying & introducing the right measures, assessment after installation, and further action if needed to overcome any unforeseen practical difficulties that may arise.
53. Limiting the time spent in noisy areas can also help to restrict daily personal noise exposure but usually only to a limited extent – halving the exposure time will reduce  $L_{EP,d}$  by only 3 dB(A). Moreover, if it is to be relied upon for this purpose, the exposure time will need to be effectively controlled. Nevertheless, any opportunity to obtain short periods out of noise, such as a noise refuge, will help by providing some relief from high noise levels and the need to wear ear protector continuously, even if this does not significantly reduce  $L_{EP,d}$ .

## Employees with variable exposure to noise

54. Where noise exposure is highly variable, either from day to day or job to job (for example construction work or in premises where employees must move about a great deal), it might be difficult to identify how far it is practicable to reduce exposure. However, the assessments should have identified the sources of noise exposure, and appropriate measures might then include:
- (a) quietening noisy equipment or tools or replacing them with quieter types, perhaps phased in over time; and
  - (b) making special arrangements to limit noise exposure, particularly if the area visited is not usually occupied, for example, by arranging for repairs in a normally unattended machine room to be done when other noisy machinery is shut down.

## New machinery

55. Long term noise reduction programmes are only likely to be effective if they include a positive purchasing policy which makes sure noise is taken into account when selecting new machinery. When making enquiries, purchasers should ask potential suppliers about information on the noise emission of machines likely to cause exposure at or above the first or peak action level.
56. Data provided by suppliers will usually be the results of tests made under standardised conditions of installation and load. It should be used when comparing different machines, before deciding which to buy, and to predict where noise assessments will be needed when the machines are brought into use.
57. It is preferable for the tests to be carried out in accordance with recognised standards (for example, BSI or international standards), where they exist, as this makes it easier to compare information provided by different potential suppliers. Where non-standard procedures are used the supplier should be asked for a clear explanation of them, and even then, skilled interpretation will probably be needed to compare the results of different kinds of test.
58. The machine maker's test data might also be useful for predicting the likely noise levels in working areas when the machines are brought into use. However, because the tests are normally made under standardised conditions, skilled interpretation will probably be needed to use the data for this purpose, and the noise will in any case need to be checked after installation.
59. As an alternative to relying on standard tests data, arrangements might be made with the supplier for machines to be delivered with a guarantee that the noise after installation will not exceed an agreed value. If this is done, the noise should be checked when the machine is brought into use.
60. Where it is necessary to purchase machinery causing employees to be exposed over the action levels, a record of the reasons for the decision will help guide future action, for example, by providing those responsible for future machine specifications with information on where improvements are needed.



## Section 9–Maintenance and Use of Equipment

61. Section 9(1) deals with the proprietor’s duty to ensure, as far as is practicable, that approved ear protectors and noise control equipments provided to or installed for the benefit of employees under Section 4, 5, 6 & 8 are properly used and maintained. This will involve the good practices outline below.

### Use of equipment

#### *Noise control equipment*

62. Regular checks will be needed to find out whether noise control equipment is being properly used. Any deficiencies should be put right promptly. There will also need to be a system enabling employees to report any defects or problems to someone with authority and responsibility for remedial action.

#### *Programme to encourage use of ear protectors*

63. People are often reluctant to use protectors, and even where they have been accepted, use tends to fall off over time. Proprietors should have a systematic programme to maintain usage, taking into account the following:
- (a) The company’s safety policy: This should include a firm commitment on personal protection.
  - (b) Signs and warning notices: to ensure awareness of where and when protectors should be used (see under Section 10).
  - (c) Clear responsibilities: The proprietor should identify who is responsible for the ear protection programme, and the distribution and maintenance of protectors.
  - (d) Information, Instruction and Training for all employees on the risks and the action they should take (see under Section 10).
  - (e) Records: These should detail issue of protectors, arrangements for ensuring users know where and how to use them, and any problem encountered in their use.
  - (f) Monitoring including spot checks to find whether the protectors are being used: A record should be kept, and deficiencies reported to a person with responsibility and authority for remedial action. Where an employee is not using protection properly, he/she should be asked why, and either the difficulty should be resolved or a verbal warning given and recorded. Where people persistently fail to use protectors properly, they should be given a written warning and normal disciplinary procedures should be followed.

## Maintenance of equipment

### *Ear protectors*

64. Re-usable protectors will need to be inspected periodically and repaired or replaced if necessary. Where disposable protectors are used, there should be checks to ensure that supplies are continuously available, with dispensers topped up regularly. The arrangements should include a system for employees to report on damaged, defective or lost protectors.
65. Proper provision should be made for clean storage of re-usable protectors, such as storage bags for ear muffs or clean lockers where they can be kept with other clothing, and strong cases for ear plugs. Where special cleaning materials are needed, these should be kept available to users.

### *Noise control equipment*

66. Noise control equipment, such as silencers or enclosures, should be checked periodically to make sure they are kept in good condition. Their effectiveness also needs to be monitored; usually spot checks of the noise level at preselected locations will be adequate (see paragraph 24).
67. The results of these checks should be reported to someone with responsibility and authority for taking remedial action.

## Employees' duties

68. Programmes for controlling noise exposure are likely to succeed only where there is co-operation between proprietor and employees. Section 9(2) deals with the employee's duty to use the ear protectors provided by the proprietor under the Regulation. Such duty will include:
  - (a) wearing suitable approved ear protectors provided at or above the second or peak action levels, in areas marked as ear protection zones or within the specified distance when operating noisy machinery. It is in their own interest to use ear protectors made available, on request, for exposure between the first and second action levels;
  - (b) taking care of suitable approved ear protectors; and
  - (c) reporting, in accordance with the proprietor's procedure, any defect found in approved ear protectors.

## Section 10– Provision of Information to Employees

69. Where employees are likely to be exposed at or above any action level, the proprietor has to provide adequate information, instruction and training as regards:
- (a) the likely noise exposure and the risk to hearing that may arise;
  - (b) how to report defects in approved ear protectors;
  - (c) what the employee should do to minimize the risk, such as the proper way to use ear protectors and other equipment, how to look after them, and where ear protectors should be used; and
  - (d) the employee’s duties under the Regulation.
70. Employees should also be advised that if any symptoms appear, such as difficulty in understanding speech or using the telephone, or permanent ringing in the ears, it is in their own interest to seek medical advice.
71. Information, instruction and training can be provided by health and safety staff and managers in various forms, including:
- (a) oral explanations;
  - (b) individual counseling and training;
  - (c) leaflets and posters;
  - (d) films, video tapes and sound recordings; and
  - (e) short local training sessions.
- No single form will be suitable for all circumstances, and reinforcement from time to time will be needed.
72. The proprietor should make sure that information is given in a form the employees understand.

## **Section 11 – Exemption**

73. This Section allows the Commissioner for Labour to exempt the proprietor of an industrial undertaking or class of industrial undertaking:
- (a) from a requirement under this Regulation if compliance with it would not be reasonably practicable; and
  - (b) from ensuring that suitable approved ear protectors are provided under Section 6 or are worn under Section 4(2)(c) where the full and proper use of an approved ear protector would cause risk to the safety and health of the user or compliance with those sections would not be reasonably practicable.
74. Situations where exemptions can be considered are broadly:
- (a) where there is concern that compulsory use of ear protectors might increase danger overall, outweighing the risk of hearing damage, for example, by making a warning sound less noticeable.
  - (b) where it is not reasonably practicable to use ear protectors meeting the general standard required by Section 6 (i.e. to reduce the risk of damage to below second or peak action level).

## **Section 12 – Offences**

75. The proprietor of an industrial undertaking, if convicted of an offence under:
- (a) Section 3(1), 3(2), 4, 5, 6(3), 8 or 9(1) is liable to a fine of \$50,000;
  - (b) Section 3(4), 3(5), 6(1) or 10 is liable to a fine of \$10,000.
76. The competent person who contravenes Section 3(3) commits an offence and is liable to a fine of \$10,000.
77. An employee who contravenes Section 9(2) commits an offence and is liable to a fine of \$10,000.

**List of Common Noisy Machinery of which Noise Assessment is usually required**

1. Abrasive cutting machinery
2. Circular cutting machinery
3. Extruding and granulating machinery
4. Glass grinding machinery
5. Marble cutting machinery
6. Metal grinding machinery
7. Paper corrugating machinery
8. Plastic granulating machinery
9. Percussive pile driving machinery
10. Power press
11. Rock / concrete breaking machinery
12. Screw / nail making machinery
13. Shuttle weaving machinery
14. Shutteless weaving machinery
15. Spinning machinery
16. Woodworking machinery (such as circular saw, planing machine, spindle moulding machine, and thicknessing machine)

## Guide on Equipment and Procedures for Noise Assessment in Working Environments

### Introduction

Noise assessment is the very first step of an effective hearing conservation programme. This guide contains advice on measuring industrial noise exposure, signposting the need for further action in order to fulfil the objectives described in paragraph 13 of the Guidance Notes.

### What is measured

2. For the purpose of the Noise at Work Regulation, any audible sound is treated as noise. The exposure to noise at the workplace comprises the noises produced there and the noises coming from the environment. Where employees are in a noisy environment, the noise should be measured in the working areas they occupy, using a procedure which obviates or minimises the effects of reflections of sound from the employee, as described in paragraphs 12-16.
3. Daily personal noise exposure ( $L_{EP,d}$ ) can be established from the measured equivalent continuous sound level ( $L_{Aeq,T}$ ) during a sample time interval  $T$ , and the duration of exposure at work.
4. Depending on the type of noise, additional measurement quantities such as the unweighted octave band sound pressure levels or the peak sound pressure level ( $L_{peak}$ ) might be required.

### Instruments

#### *Integrating sound level meters*

5. The most convenient instrument for general purpose use is an integrating sound level meter complying with at least the requirements for a Class 2 instrument given in BS EN61672-1:2003. Class 1 instruments are preferred (Class 1 and Class 2 are performance categories. Tolerance limits for Class 2 instruments are generally larger than for Class 1). This will be capable of measuring the value of equivalent continuous sound level over the whole day, or over sample periods from which  $L_{EP,d}$  can readily be calculated.

### *Simple sound level meters*

6. Simple sound level meters complying at least with the requirements for a Class 2 instrument given in BS EN61672-1:2003 are suitable for measurement of continuous or intermittent periods of steady noise (for example in a weaving shed). They are very convenient for making routine spot checks when reviewing assessments (see paragraph 24 of the Guidance Notes).

### *Noise dosimeters (Personal sound exposure meters)*

7. These are worn by the person whose exposure is being determined, to measure the total noise dose over the whole working period. The microphone usually has to be located very close to the person's body, so reflections may affect the result. The British Standard for these meters is BS EN61252:1997. In order to avoid the instrument being overloaded by the peak sound pressure, instruments incorporating an overload indication are preferred.

### *Peak pressure*

8. A very rough check to estimate whether measurements of peak pressure with more sophisticated instruments are needed can be made with a simple sound level meter set to 'Fast' response. If the reading exceeds 125 dB(A), it should be assumed that more accurate measurements ought to be made. To do this, an instrument with a rise or onset time of 100 microseconds or less will be needed. The equipment should have an unweighted response to the main audible frequencies, but exclude frequencies too high or too low to be significant. C-weighting will be suitable for this. The 'LIN' characteristics can also be used although if the instrument has an extended frequency response, it might respond to frequencies outside the main audible range, resulting in a higher reading.
9. Sound level meters complying with BS EN61672-1:2003 with Class 1 Specification and set to Peak Hold will meet the above requirement. Note that there are very few situations where an exposure above the peak action level does not yield an  $L_{EP,d}$  greater than 90 dB(A).

## Calibration and checking

10. Each time before and after noise measurements, the acoustic properties of the sound level meter should be checked by means of an acoustic calibrator or pistonphone with an accuracy of at least 0.5 dB.
11. A full calibration of equipment can only be verified in a properly equipped laboratory, and this should be done periodically. Normally the interval should not exceed 2 years.

## Measurement procedure

### *General*

12. The measurement should provide typical quantitative description of the characteristic potential noise exposure of employees in the workplace. To achieve this, a sufficient number of independent measurements (samples) by integrating sound level meter must be performed. The measurement duration should be long enough for the resulting noise exposure level to be representative of the activities performed by the employees. The duration should be either the entire length of an activity, a portion thereof, or several repetitions of the activity, as required to obtain a steady meter reading within 0.5 dB. In any case, the integrating time should be at least 15 seconds. The integrating sound level meter should be set at 'Fast' response and held at arm's length to avoid reflections and blocking of sound from some directions. Windshield must be used when measurement is done outdoor in order to reduce wind noise, dust and humidity effects.

### *Microphone location*

13. Ideally, the measurements should be made in the 'undisturbed field', i.e., in the absence of the person whose exposure is to be measured, with the microphone located in the area normally occupied by the person's head.
14. Often operators need to be present while the measurements are made, for example, to control the machine. Measurements should be made with the microphone positioned close enough to the operator's head to obtain a reliable assessment of the noise to which they are exposed, but preferably not so close that reflections from them cause errors. The results are unlikely to be significantly affected by reflections if the microphone is kept at least 4 cm away from the operator. The microphone should be placed on the side subject to most noise.
15. When using a personal noise dosimeter, the microphone has to be mounted very close to the person's body; reflections from the body will reduce measurement accuracy. Locations very close to the outer ear are particularly affected and should be avoided if possible. The usual locations of microphones for dosimeters are shown in Fig. 1. When the microphone is at the 'B' position, a slightly higher readings (about 2 dB(A)) will be obtained.



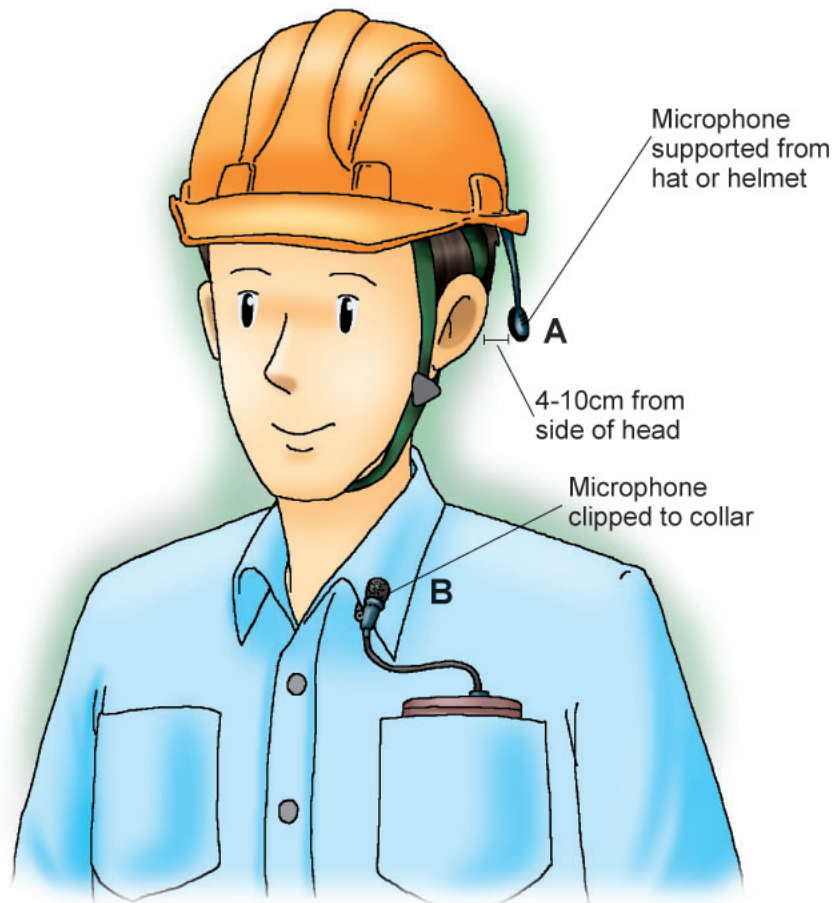

A - head-mounted microphone  
B - collar or shoulder-mounted microphone

Fig. 1 Location of microphones for dosemeters

16. Occasionally a microphone within, or very close to, the external ear has to be used, for example, when using microphone to measure the sound pressure level under a headset, headphone, or inside a shotblasting helmet. This will produce results which are difficult to compare directly with the First and Second Action Levels because the measured values might need to be adjusted to obtain a notional undisturbed field pressure level. The technique is still being developed and should be carried out by someone with specialist knowledge.

#### *Single site measurements*

17. When the exposure to noise of an employee who works at an approximately fixed location relative to the noise source has to be determined, measurements in terms of  $L_{Aeq,T}$  should be made in one of the following ways:
  - (a) with the employee absent, the microphone being located at approximately head height at the employee's normal working position; or
  - (b) with the employee present, the microphone being located close to the side of the head having the higher sound level.

### *Area measurements*

18. When a number of employees work in an area of approximately equal sound level, the following procedure may be used to determine the average sound level to which the employees are exposed.
19. Measurements in terms of  $L_{Aeq,T}$  should be made at not less than 4 locations which are representatives of the positions occupied by the employees, and well distributed over the area to be tested. Normally the microphone should be placed about 1.5 metres above the floor for standing employees and 0.8 metre for seated employees. The sound levels should be averaged to obtain the level for the area. The locations should be selected to enable the worst likely exposure to be calculated.
20. The highest sound level to which employees are exposed within an area should differ from the lowest by less than 5 dB(A). Any place occupied by employees where the sound level differs by more than this should be treated as a separate site or area. This will provide useful information to indicate for each separate area its respective levels of exposure.

### *Employees who move about with highly variable exposures*

21. If employees move from one area to another or perform various jobs, their daily personal noise exposures may be measured by monitoring the sound level to which they are exposed as they perform their work. A portable magnetic tape recorder, a noise dosimeter, or any other apparatus capable of measuring the personal sound exposure of the employee may be used for this purpose, provided that the equivalent continuous sound level can be determined from the instrument readings.
22. As an alternative to monitoring the sound level during normal work, it may be possible to determine the 'fractional exposure' resulting from each of the jobs carried out by the employee. The daily personal noise exposure can then be determined by combining the various exposures from each job, using the rules set out below.

### **Method of calculating $L_{EP,d}$**

23. To obtain  $L_{EP,d}$ , measurements in  $L_{Aeq,T}$  will need to be adjusted to take account of the length of time an employee is likely to be exposed to the noise. One way is to use the nomogram in Fig. 2.

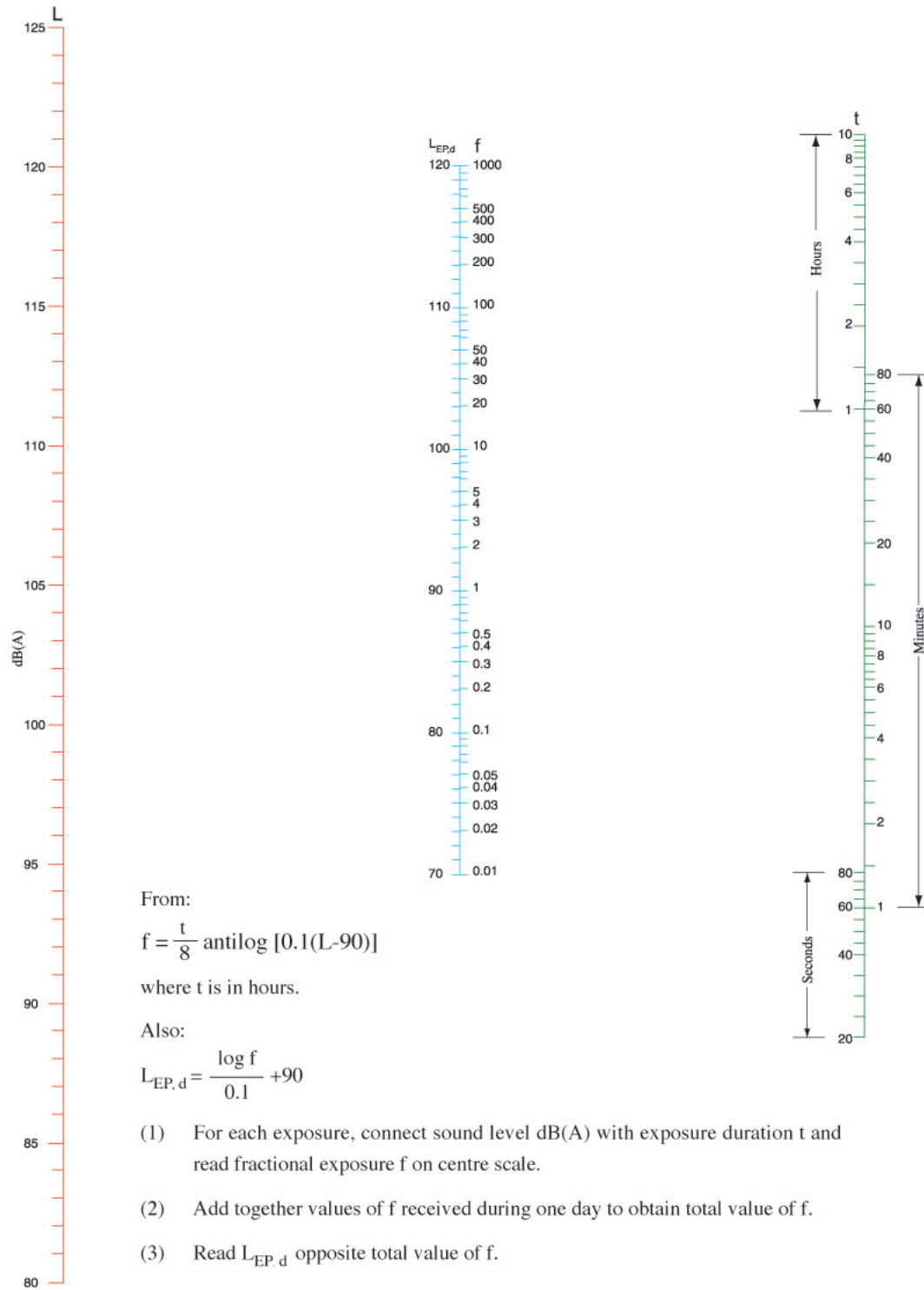

Fig. 2 Nomogram for calculation of  $L_{EP,d}$

*Where there is only one significant level of noise during the day*

24. The  $L_{EP,d}$  value can be obtained from the nomogram in Fig. 2 by drawing a straight line connecting the measured value on the L scale with the exposure duration on the t scale.  $L_{EP,d}$  can be read at the point of intersection with the centre scale.

*Example 1.* An employee is exposed to a sound level of 103 dB(A) for 3 hours per day. During the rest of the day the level is about 76 dB(A) which may be ignored.

From Fig. 2,  $L_{EP,d} = 99$  dB(A) (rounded up to the next higher dB)

*When there is more than one significant noise level*

25. Exposure at each significant level can be converted to a value of ‘fractional exposure(f)’ using Fig. 2. The values of ‘f’ obtained during one day should be added together, and the total value of f converted to  $L_{EP,d}$  using the centre scale of the nomogram.

*Example 2.* An employee is exposed to the pattern of noise in the first 2 columns of the table below.

The third column shows the corresponding values of f which are added together and converted to  $L_{EP,d}$ :

Noise level dB(A)	Exposure duration	f (from Fig. 2)
112	30 min.	10
108	45 min.	6
95	1 hour	0.4
TOTAL		16.4

From Fig. 2,  $L_{EP,d} = 102$  dB(A) (to the nearest whole dB(A))

26. Alternatively,  $L_{EP,d}$  can be calculated by the following formula:

$$L_{EP,d} = 10 \log \frac{1}{8} \left[ \sum_{i=1}^n t_i \times 10^{\frac{L_{PA_i}}{10}} \right]$$

where  $t_i$  = exposure duration in hour of the  $i$  th measurement

$L_{PA_i}$  = noise level in dB(A) of the  $i$  th measurement

*Example 3.* Using the data in Example 2,

$$L_{EP,d} = 10 \log \frac{1}{8} \left[ \frac{30}{60} \times 10^{11.2} + \frac{45}{60} \times 10^{10.8} + 1 \times 10^{9.5} \right]$$

$$= 102 \text{ dB(A) (to the nearest whole dB(A))}$$

### Single event noise

27. For some machines, such as cartridge-operated fixing tools, it may be convenient to establish the noise dose caused by a single operation of the machine. This can be achieved by using an integrating meter capable of measuring the  $L_{eq}$  over a sample period, or some other measure of the total noise, such as Sound Exposure Level (SEL), to measure the noise when the machine is operated a known number of times.

*Example 4.* The noise from a device producing an impact had the characteristics illustrated in Fig. 3. To establish the dose, the noise was measured with an integrating meter and the fractional exposure caused by each operation calculated as follows:

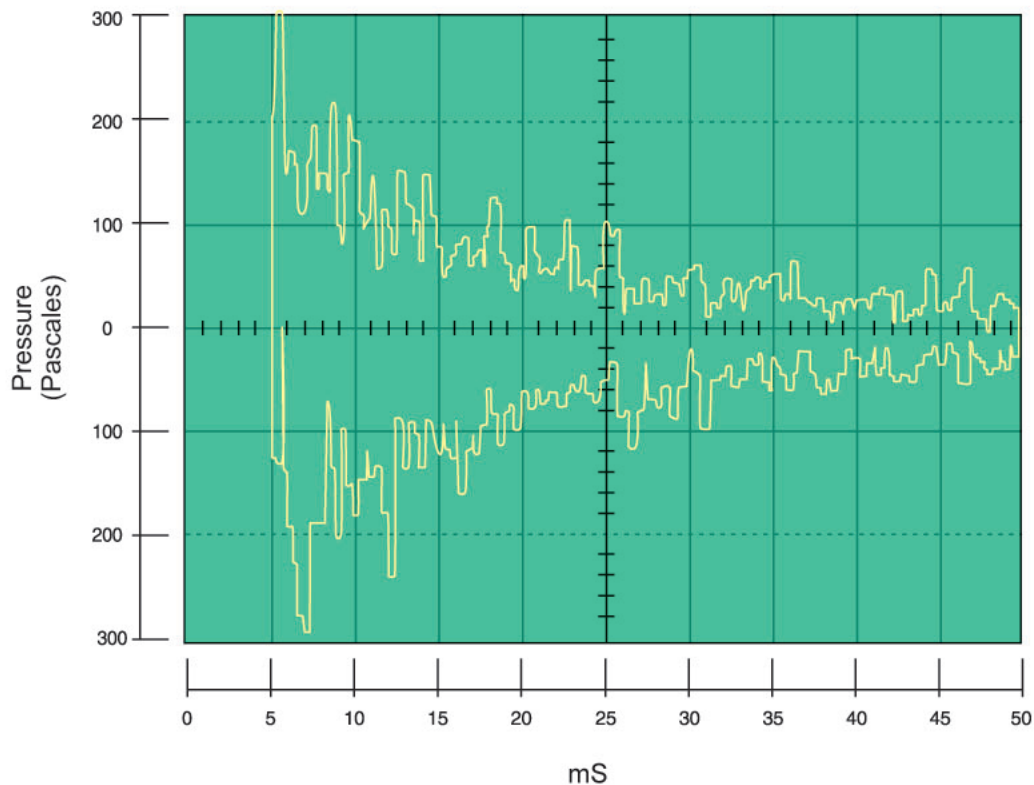

Fig. 3 Time history of an impact noise

- The meter was switched on and the device operated 10 times.
- After 5 minutes (a period arbitrarily chosen for convenience in operating the device and reading the meter) the meter indicated a value of  $L_{eq}$  of 99 dB(A).
- The background noise was measured over a similar period and found to be 60 dB(A) which can be neglected.
- From Fig. 2, a level of 99 dB(A) for 5 minutes will cause a fractional exposure of 0.08.
- Therefore fractional exposure for a single operation of the device is 0.008 (i.e., 125 operations will cause a fractional exposure of 1 or an  $L_{EP,d}$  of 90 dB(A)).

### *Value of $L_{EP,d}$ caused by repeated single event noise*

28. If the value of 'f' known for a single operation, this can be multiplied by the number of operations per day to obtain the total daily exposure which can then be converted to  $L_{EP,d}$  using Fig. 2.

*Example 5.* The tool used in Example 4 is operated 800 times per day. Other noise is negligible.

$$\text{Total daily value of } f = 800 \times 0.008 = 6.4$$

From the centre scale of Fig. 2,  $L_{EP,d} = 98 \text{ dB(A)}$

### **Records of assessments**

29. Records of assessments should be entered in the appropriate Noise Assessment Report (see Appendix 3). A copy of the report should be sent to the Labour Department within 28 days after completing the assessment.

[section 3(3)]  
[規例第 3(3)條]

**Noise assessment Report**  
**噪音評估報告**  
**Factories and Industrial Undertakings (Noise at Work) Regulation**  
**工廠及工業經營（工作噪音）規例**

Name of Industrial Undertaking : \_\_\_\_\_  
 工業經營名稱  
 Address : \_\_\_\_\_  
 地址  
 Date of survey : \_\_\_\_\_ Ref. No. : \_\_\_\_\_  
 測量日期 檔案號碼  
 Survey made by : \_\_\_\_\_ Occupation : \_\_\_\_\_  
 測量員 職業  
 Training/experience : \_\_\_\_\_  
 訓練/經驗

Item No. 項目號碼	Brief description of area/location machinery/plant activity/task 地區/地點 機器/廠房 活動/工作簡述	Noise level 噪音級數		Daily exposure period 每天暴露時間	L <sub>EP,d</sub> dB(A) 分貝(A)	No. of employees exposed 暴露於噪音中的僱員數目	Description of ear protector (if provided) 描述聽覺保護器 (如有提供)	Description of demarcated ear protection zone (comment if not demarcated) 描述聽覺保護區的劃定 (若沒有劃定請評論)
		L <sub>Aeq,T</sub>	L <sub>peak</sub> (where appropriate 如適用)					

General comments : \_\_\_\_\_  
 一般評論

Instrument used : \_\_\_\_\_  
 使用儀器

Date of last calibration : \_\_\_\_\_  
 上次校準日期

Signature : \_\_\_\_\_  
 簽名

Date : \_\_\_\_\_  
 日期

Note : This report must be sent to Commissioner for Labour within 28 days of completing the assessment.  
 註：本報告必須在完成評估後 28 天內送交勞工處處長

NOISE-AR

## Guide on Types and Selection of Suitable Ear Protectors

### Introduction

This Appendix provides detailed advice on types of ear protectors and their proper selection. It must be stressed that only those types of ear protectors approved by the Commissioner for Labour are to be used in accordance with this Regulation.

### Types of ear protector

#### *Ear muffs*

2. These are normally hard plastic cups which fit over and surround the ears, and are sealed to the head by cushion seals filled with a soft plastic foam or a viscous liquid. The inner surfaces of the cups are covered with a sound absorbing materials, usually a soft plastic foam.
3. Various kinds of headband are used to hold and press the muffs to the head. They need to be treated with care to avoid overbending or distorting the pressure straps, which will degrade the acoustic performance.
4. Ear muffs have several advantages compared with ear plugs. One size will fit most people and they are easy to remove and replace – an advantage for people who frequently move from a noisy to a quiet place. However, they tend to make the ears hot, are bulky and less convenient if slipped around the neck when not in active use.
5. Communication equipment can be built into ear muffs, receiving signals from a wired or aerial system. This allows information to be relayed to the wearer, and may encourage wearing. In some circumstances however, they might detract from overall safety. The following safety points must be watched:
  - (a) the sound level produced inside the muffs need to be limited to avoid creating a new noise hazard;
  - (b) where the muffs are used to receive spoken messages, the microphone should, where possible, be switched off when not in use to avoid spurious background noise;
  - (c) checks should be made to make sure that it is possible to hear necessary warning sounds above the sounds introduced into the muff. If necessary, a louder alarm, or one with a more distinct character, should be used; and
  - (d) alarms need for safety should not normally be relayed through the system because of the risk of system failure, unless it can be designed to ‘fail-safe’.



6. The headsets supplied with personal stereos usually provide little or no attenuation of external noise and should not be relied on to provide ear protection.

### *Ear plugs*

7. Ear plugs fit into the ear canal. They sometimes have a cord or neck band to prevent loss. Some types are intended to be used for a very long time (permanent), some to be thrown away after one use (disposable) and others to be used just a few times (reusable).
8. Ear plugs will probably not be suitable for persons suffering from ear disease.

### *Permanent rubber or plastic plugs*

9. These are usually available in a range of sizes. To obtain a good seal in the ear canal it is essential that the correct size is used, resulting in a slightly tight fit. Some people need a different size plug for each ear.
10. The so-called 'universal-fitting' ear plugs are also available. These have administrative advantages because one size can fit most people, but they are usually less reliable than plugs supplied in various sizes. They are also prone to misuse because they can be retained in the ear even when not fully inserted, resulting in little protection.
11. 'Custom moulded' ear plugs are made from a material such as silicone rubber individually moulded to fit a person's ears. This can give good results and are comfortable. They must be made by someone trained in the process.
12. Reusable plugs need to be cleaned regularly and replaced when they have lost efficiency. The material will degrade with age, resulting in loss of fit and protection, so the proprietor's programme needs to include provision for regular replacement. The supplier should be asked for advice on suitable methods of cleaning and the life expectancy of the ear plugs.

### *Disposable and 'reusable' ear plugs*

13. These are convenient to issue and widely used. They are made from various compressible materials such as plastic foam, or fine mineral down (often contained in plastic membrane). They have the advantage of being able to fit most people without requiring specialist fitting.

### *Semi-inserts*

14. These are pre-moulded ear caps attached to a headband which presses them against the entrance of the ear canal. To make an effective seal, the headband needs to press the caps firmly into the ear canals, and some people find the pressure intolerable, especially over long periods. Others find them convenient because they can be slipped off easily in quiet periods.

## Special types of ear protector

15. Various other types of ear protector available are designed to deal with specific problems. They include frequency selective, amplitude sensitive, active attenuation and noise-excluding helmets. However, they are not suitable for general use in industry.

## Suitability for the individual, fitting and training

16. Whichever type of ear protector is used, it will only provide the assumed protection if it is in good condition, it fits and is suitable for the individual and is worn properly.
17. All permanent ear plugs, including the 'universal fitting' type should be initially fitted to the individual by a trained person who should instruct the user the correct method of insertion.
18. Ear muffs do not need specialist fitting, but the fit should be checked to make sure that they completely surround the ear, and the seal is in contact with the head all round.
19. The necessary information, instruction and training provided to employees on the use of ear protectors include:
  - (a) how to insert ear plugs;
  - (b) the importance of correctly fitting ear muffs; and
  - (c) the importance of cleanliness in preventing infection and how to clean ear protectors.

## Maintenance

20. Ear protectors must be maintained in good condition. Points to check include:
  - (a) the condition of ear muff seals, which may be torn or become hardened with age;
  - (b) the tension of headbands;
  - (c) unauthorized modifications such as holes drilled in ear muffs;
  - (d) resilience and softness of ear plugs; and
  - (e) general cleanliness

With experience, simple checks can be made by inspection and feel. It is a good practice to keep a set of ear protectors in new condition to provide a basis for comparison.

## Comfort

21. All ear protectors are likely to be somewhat uncomfortable, especially in hot, sweaty conditions. Careful selection can minimize this, but it is necessary to strike a balance between comfort and other requirements such as durability, degree of protection and suitability for the job.

22. The main factor affecting the comfort of ear muffs is the pressure of the seals on the head. This can be kept low by using seals which need only a low headband force. A high contact area between seal and head also helps, but in hot conditions a low contact area helps to reduce sweating. Liners which fit between seal and head can absorb sweat, but may reduce protection; the assumed protection (see paragraph 27) should be calculated from test data which take their use into account. Other important factors include the weight of the muffs (the lighter the better) and cups large enough to cover the wearer's external ear.
23. The comfort of ear plugs will mainly depend on the pressure on the contact area between ear canal and ear plug. Types which can conform readily to the wearer's ear canal, and 'custom moulded' plugs will usually be found most comfortable.
24. Comfort is a matter on which people vary considerably. Some prefer ear plugs in hot environments, but others find any ear plug extremely uncomfortable and prefer muffs. Wherever possible, the proprietor should select more than one type of suitable ear protector and allow the user a personal choice among them.

### Efficiency of protection

25. The 'assumed protection' calculated from test data can only be provided if the ear protectors fit and are properly worn. In practice, many factors militate against this, such as:
  - (a) Interference with ear muff seals. As illustrated in Fig. 1, anything between the seal and head is likely to reduce performance. Goggles and spectacles should have thin frames, or should be held by straps which do not pass under the seal. Long hair and beard can also reduce the performance of muffs.

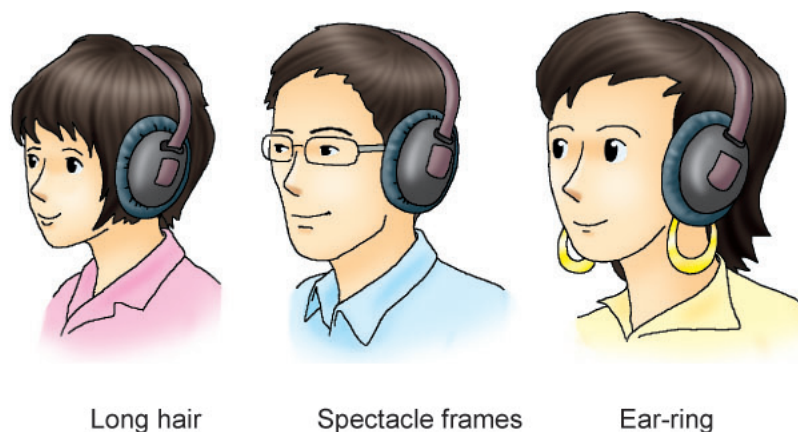

Fig. 1 Some reasons why the seals of ear muffs do not always work properly

- (b) Ear muffs incompatible with other equipment worn. Helmets and face shields might prevent ear muffs fitting correctly if there is insufficient space between them and the muffs. Where ear muffs have to be worn inside a helmet, such as shotblaster's helmet, the wearer's ability to move their head comfortably will need to be checked. Ear plugs are often the easiest way of avoiding compatibility problems.
- (c) Poor seating of ear plugs: Ear plugs need to be properly inserted into the ear to make a good seal.
- (d) Failure to use ear protectors all of the time in noisy areas: If the protectors are removed in noisy places, even for short periods, the amount of protection provided will be severely reduced. For example, if a very efficient protector with an assumed protection of 30 dB(A) is removed for 30 minutes per day, the actual reduction in noise dose received by the user will only be about 12 dB(A), i.e. a loss of 18 dB(A) protection. Table 1 shows the protection actually received if protectors are not worn for periods in an 8-hour shift.

Hours worn in 8-hour shift	8	7	6	5	
Protection Provided by Ear protector dB(A)	Nominal Protection	Actual Protection			
	30	9	6	4	
	20	9	6	4	
	10	7	5	3.5	

Table 1 Protection provided by ear protector with exposure time

### To calculate the protection provided using test data

#### *Test data on attenuation*

- 26. All approved ear protectors are provided with attenuation data complying with BS EN24869-1: 1993 or other national standards. The data are supplied as the mean value with a standard deviation for each frequency tested.

#### *Calculating 'assumed protection' from the data*

- 27. It can be assumed that the protection given to most people (about 84%) is equivalent to the mean attenuation minus the standard deviation at each test frequency. See Example 1 below.

*Example 1.* BS EN24869-1:1993 test data for an approved ear protector is given below. The assumed protection is obtained by subtracting the standard deviation from the mean value.

Frequency (Hz)	63	125	250	500	1K	2K	4K	8K
Mean attenuation (dB)	21.7	22.0	21.3	20.3	23.0	29.8	44.9	43.3
Standard deviation (dB)	4.4	4.9	5.8	5.1	4.6	5.5	4.2	5.2
Assumed protection (dB) (rounded to the nearest whole no.)	17	17	16	15	18	24	41	38

28. The overall assumed protection will depend on the frequency composition of the noise, and will be equal to the difference between the actual noise exposure and the assumed protected level (APL) calculated as below.

*Assumed protected level of exposure (APL)*

29. To calculate APL, a frequency analysis of the measured noise will be needed. This is best done as octave band values of  $L_{EP,d}$ . Selection can also be based on an eye-average value of octave band sound pressure levels for the noisiest period, using a simple sound level meter provided the fluctuations do not exceed 5 dB(A) when the instrument is set to ‘Slow’ response.
30. The assumed protection for each frequency should be subtracted from the measured values of octave band sound pressure levels, to obtain values of APL, which should be converted to an A-weighted value of APL using the procedure explained below.

*Method 1*

31. The procedure is as follows:
- (a) The A-weighting correction given in Table 2 is added or subtracted arithmetically to each octave band sound pressure level.

Octave band centre frequency (Hz)	63	125	250	500	1K	2K	4K	8K
A-weighting correction	-26	-16	-8.5	-3	0	+1	+1	-1

Table 2 A-weighting corrections

- (b) The A-corrected octave band levels are summed in a pair-wise fashion starting from the lowest levels, using Table 3 :

Difference in dB(A) between two sound levels being summed			Amount of dB(A) to add to the higher sound level
0	to	0.5	3.0
1.0	to	1.5	2.5
2.0	to	3.0	2.0
3.5	to	4.5	1.5
5.0	to	7.0	1.0
7.5	to	12.0	0.5
more than 12.0			0

**Table 3** Summation of sound levels

- (c) The final total sound level is rounded to the nearest whole dB(A) with values of 0.5 or more being rounded upwards.

*Example 2.* A noise with a level of 110 dB(A) has octave band sound pressure levels as shown below. Values of assumed protection from Example 1 are used to obtain octave band levels of APL.

Column 1	Column 2	Column 3	Column 4	Column 5
Octave band centre frequency (Hz)	Octave band sound pressure level (dB)	Assumed protection (dB) (from Example 1)	A-weighting correction (dB) (from Table 2)	A-corrected octave band level (dB) (Column 2-Column 3+Column 4)
63	89	17	-26	46
125	91	17	-16	58
250	95	16	-8.5	70.5
500	100	15	-3	82
1K	102	18	0	84
2K	105	24	+1	82
4K	104	41	+1	64
8K	98	38	-1	59

To sum the A-corrected octave band levels (Column 5), take the two lowest levels (46 & 58) as the first pair for adding as below and then take the result of this adding and the next lowest level from the remaining levels for further adding, until all levels are similarly added:

- Find the difference between them i.e. 12 dB(A)
- Read from Table 3 the figure to be added (i.e. 0.5 dB(A), the corresponding figure for the difference of 12 dB(A))

- (c) Add this figure to the higher sound level, i.e.  $58 + 0.5 = 58.5$  dB(A)
- (d) Add this result to the next lowest level (59) of the remaining levels,  
i.e.  $58.5$  dB(A) +  $59$  dB(A),  
 $= 59 +$  a figure corresponding to a difference of  $0.5$  dB(A)  
 $= 59 + 3$   
 $= 62$  dB(A)
- (e) Add this result to the next lowest level (64) of the remaining 5 levels,  
i.e.  $62$  dB(A) +  $64$  dB(A),  
 $= 64 + 2$  (for a difference of  $2$  dB(A))  
 $= 66$  dB(A)
- (f) Add this result to the next lowest level (70.5) of the remaining 4 levels,  
i.e.  $66$  dB(A) +  $70.5$  dB(A),  
 $= 70.5 + 1.5$  (for a difference  $4.5$  dB(A))  
 $= 72$  dB(A)
- (g) Add this result to the next lowest level (82) of the remaining 3 levels,  
i.e.  $72$  dB(A) +  $82$  dB(A),  
 $= 82 + 0.5$  (for a difference  $10$  dB(A))  
 $= 82.5$  dB(A)
- (h) Add this result to the next lowest level (82) of the remaining 2 levels,  
i.e.  $82.5$  dB(A) +  $82$  dB(A),  
 $= 82.5 + 3$  (for a difference  $0.5$  dB(A))  
 $= 85.5$  dB(A)
- (i) Add this result to the remaining level,  
i.e.  $85.5$  dB(A) +  $84$  dB(A),  
 $= 85.5 + 2.5$  (for a difference of  $1.5$  dB(A))  
 $= 88$  dB(A)

This approved ear protector is considered suitable for the working environment provided the total exposure time is not more than 8 hours, i.e. exposure is below the second action level when used.

## Method 2

32. The sum of the A-corrected octave band levels can be obtained by the following formula:

$$\text{Sum} = 10 \log_{10} \left[ \sum_{i=1}^n 10^{\frac{L_{PA_i}}{10}} \right] \text{dB(A)}$$

Where  $L_{PA_i}$  = noise level in dB(A) of the  $i$  th band

*Example 3.* Using the data in Example 2,

$$\begin{aligned} \text{Sum} &= 10 \log_{10} [ 10^{4.6} + 10^{5.8} + 10^{7.05} + 10^{8.2} + 10^{8.4} + 10^{8.2} + 10^{6.4} + 10^{5.9} ] \\ &= \underline{\underline{88 \text{ dB(A)}}} \text{ (rounded to the nearest whole dB(A))} \end{aligned}$$

## Dual protection

33. Situation may arise where the noise level is extremely high, such that the best ear muffs or plugs available, used alone, might not be capable of providing enough value of assumed protection. This problem is likely where  $L_{EP,d}$  exceeds about 115 dB(A), especially if there is substantial noise at frequencies less than 500 Hz.
34. Improved protection can be obtained by wearing a combination of ear muffs and plugs. Fig. 2 shows the improvement obtained in one particular combination. The value of assumed protection will depend on the particular muff and plug used. In general, the most useful combination is a high performance plug with a moderate performance muff—a high performance ear muff adds a little extra protection but is likely to be less comfortable.
35. There is no general rule for using the test data provided with ear muffs and plugs to estimate the assumed protection they will provide in combination. Each combination will need to be tested using a recognized procedure such as BS EN24869-1:1993.

## 'Single number' ratings for attenuation

36. To avoid the need for a frequency analysis of the noise and simplify selection of ear protectors, several systems have been proposed in which the assumed protection is given as a single overall number. One system is used in the USA, where all ear protectors carry a 'Noise Reduction Rating' (NRR value). At present, however, none of the systems is recommended in connection with the Regulation.
37. When these systems are designed there is usually a conflict between simplicity and accuracy. Simple systems do not forecast the protection accurately, and in making sure that errors are usually on the safety side leaving many people overprotected, and expected to wear ear muffs heavier and less comfortable than really required. More accurate systems tend to be more complicated to use.



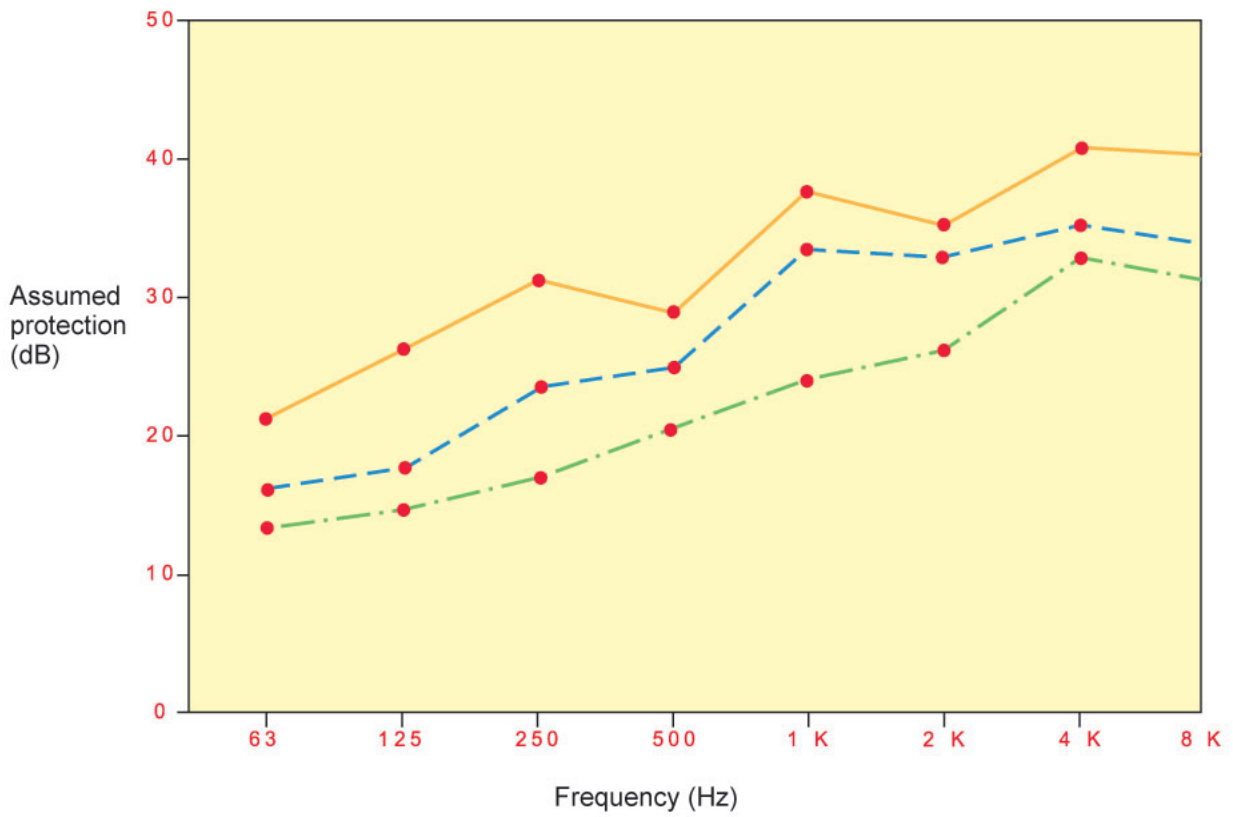

- - - - ● Assumed protection of the ear plugs worn alone (high performance conformable)
- - - - ● Assumed protection of the ear muffs worn alone (high performance)
- - - - ● Assumed protection of the ear plugs and ear muffs in combination

NOTE: This shows the assumed protection provided by only one combination of muffs and plugs. Before reliance is placed on protectors used in combination, similar data should be obtained for the particular combination to be used.

Fig. 2 Dual protection - ear muffs and plugs worn in combination

## Guide on Industrial Noise Control

### Introduction

There are many ways of reducing noise in workplaces, and this Guide outlines some that should be considered. Application of noise control technology can be difficult and must be designed by someone with knowledge and skill. Noise control engineers will also need to understand the processes involved or collaborate with others.

### Substitution of a quieter process or machine

2. Sometimes a noisy process can be replaced by a quieter one such as welding instead of riveting, hydraulic instead of percussive pile driving. Hence, sometimes a working knowledge of the noisy processes and alternative ways of doing the jobs may be more important than specialized acoustic training.

### Reduction at source

3. For most industrial noise problems, there will often be several sources which will need to be tackled, and it is good practice to establish the contribution that each makes to the total noise generated, and then to deal first with those that will produce noticeable improvements for least effort.
4. Noise control at source is the most effective approach for solving noise problems and should be considered first. Some of the methods of preventing noise generation that should be considered are:
  - (a) Avoiding impacts, or arrangements to cushion them: Example includes rubber or plastic surface coatings to avoid metal to metal impacts;
  - (b) Reducing the area of the vibrating surfaces: Example includes replacement of plain panel by perforated panel;
  - (c) Reducing the magnitude of vibration of surfaces by increased damping: Example includes applying damping material to sheet metal;
  - (d) Silencers to reduce noise generated by turbulence at air exhausts and jets: Example includes a porous silencer for the exhaust of a pneumatic cylinder;
  - (e) Matching of air supply pressure to the actual needs of pneumatic equipment: By providing each unit with its own pressure reducing valve, the supply can be individually adjusted for a good compromise between reliable operation and noise;

- (f) Low noise air nozzles, pneumatic ejectors and cleaning guns constructed on good aerodynamic principles;
- (g) Arrangements to make sure that noisy devices are only used when actually needed: For example the pneumatic ejector on a power press need be on only for the short time required to eject the products;
- (h) Dynamic balancing of rotating parts;
- (i) Reducing noise by proper machine maintenance such as lubrication;
- (j) Improved design of fans and compressors and their accurate matching to the systems they supply;
- (k) Reducing the need for noisy assembly practices by better quality control, design and manufacturing procedures: For example, precision casting reduces the need for chipping and grinding processes to rectify faults or trim surplus material; and
- (l) Attention to the stiffness of structural parts of machines: For example, making sure that if a power press is intended to be used with tie bars, they are in fact fitted.

### **Modification of the paths by which noise reaches workplaces**

5. The routes between the points at which noise is generated and the workplace can sometimes be modified to reduce noise exposure of employees. Some of the measures which should be considered are:
  - (a) Acoustic enclosures of noisy machines and partial enclosures or covers around noisy parts of machines: Fig. 1 shows the features of a typical machine enclosure.
  - (b) Anti-vibration mountings or heavy bases under machines to reduce structure-borne sound.
  - (c) Screens with sound absorbing material placed between employees and noisy areas.
  - (d) Enclosure of the workplace by provision of a booth or 'noise refuge' (with proper attention to the ventilation and seating arrangement): If controls are brought into the booth, it will be possible to reduce the need to enter noisy areas. Even where the employee still needs to use ear protector outside the noise refuge, it can help by providing relief from the need to wear the protector continuously. AND
  - (e) Sound absorbing material to control reflection within workplaces: As shown in Fig. 2 near to the source, most sound is received by direct radiation from the machine, but further away the noise received via the direct and reflected paths is more nearly equal. Absorbing material should be attached to reflecting surface close to the noise source. Otherwise, reduction is only effective further away from the source.

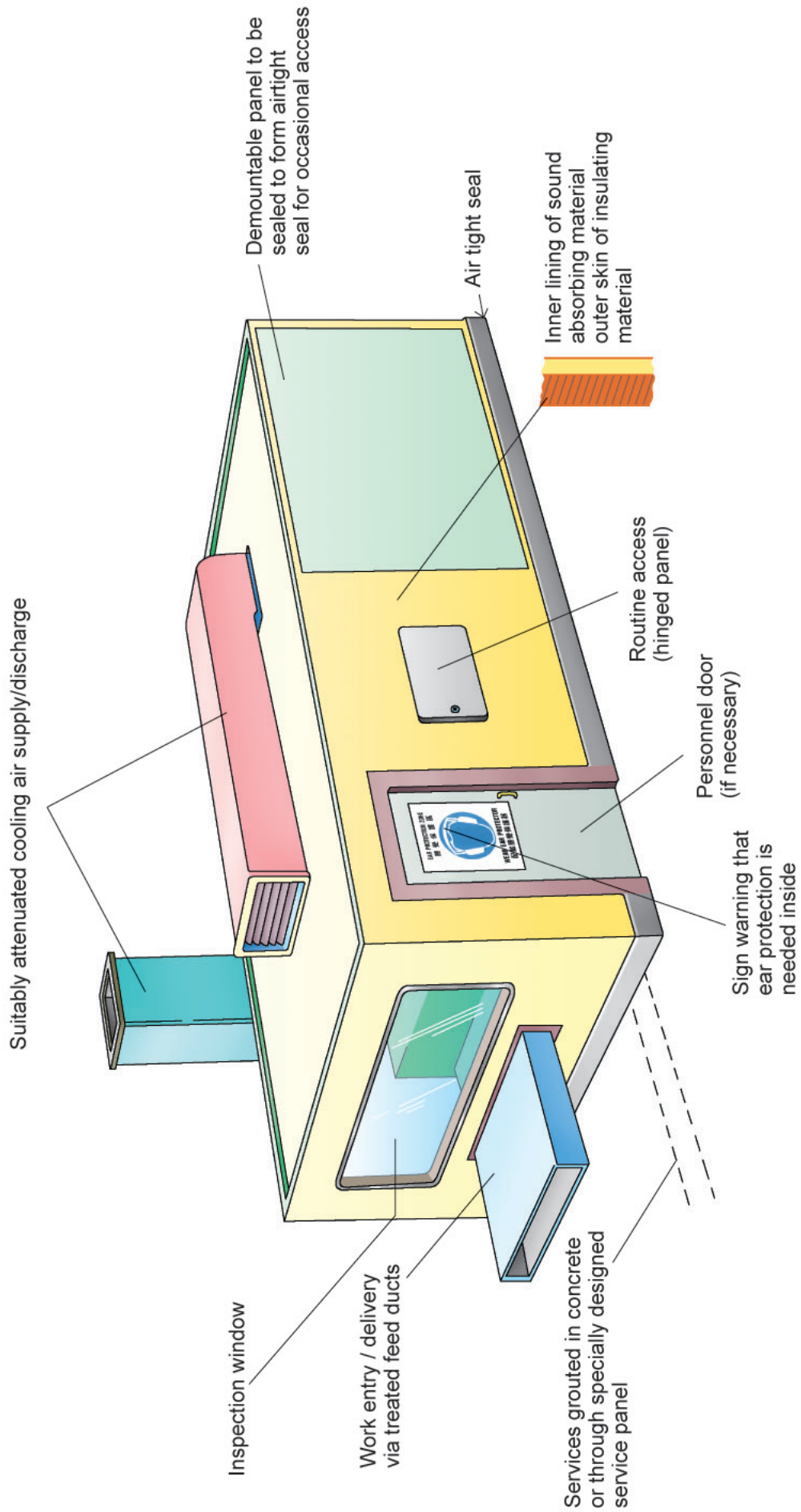
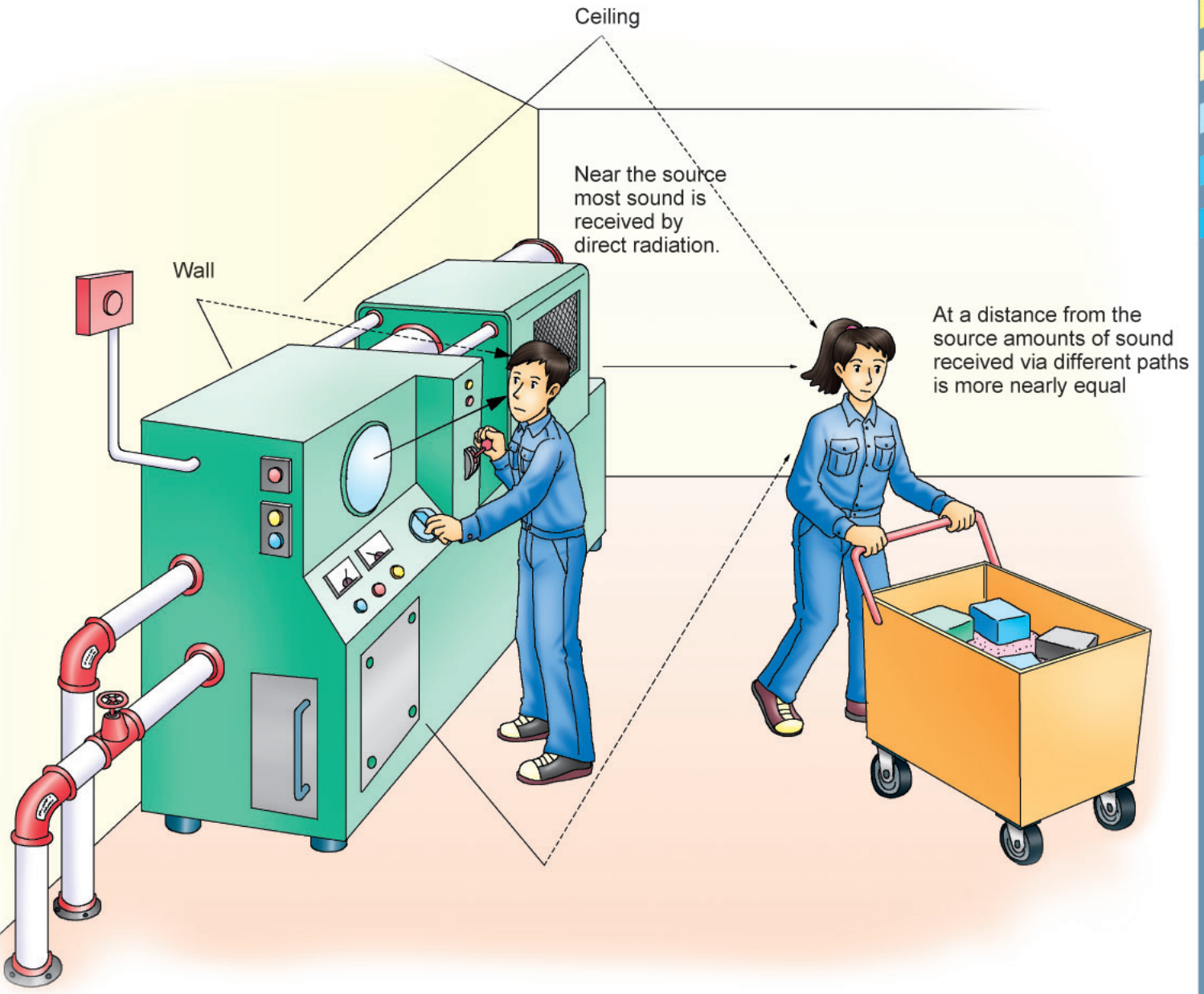

Fig. 1 A machine acoustic enclosure



— Direct sound

---- Reflected sound

width of arrowhead roughly proportional to sound energy

Fig. 2 Routes by which airborne noise reaches employees

6. Fig. 3 shows how the noisy parts of a power press are treated to reduce noise. The measures involved include acoustic panels, pneumatic silencers and damping materials. A noise reduction of about 20 dB(A) might be achieved.

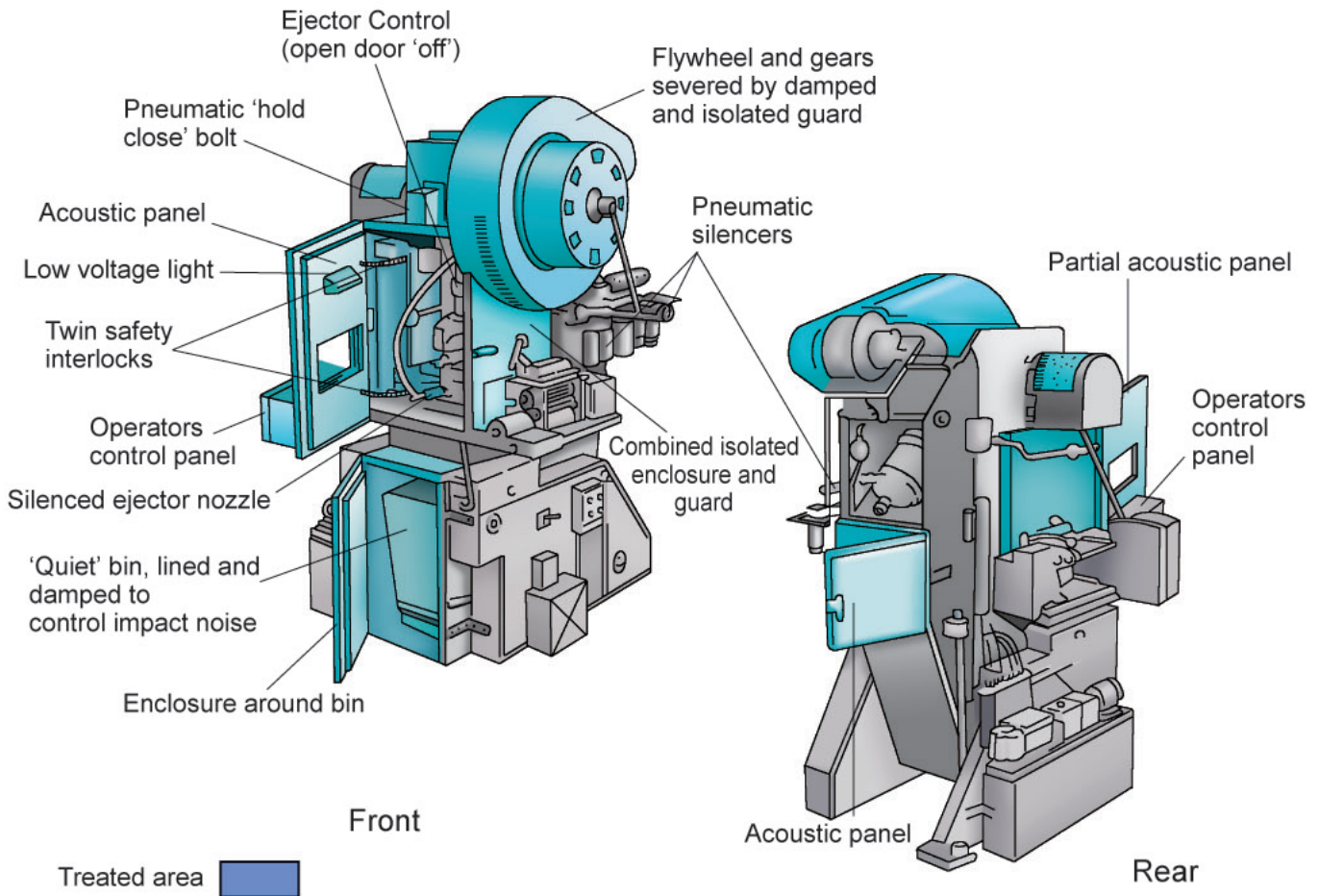

Fig. 3 Application of control measures to power press

### Distance

7. Increasing the distance between a person and the noise source can provide considerable noise reduction (inverse square law). Some ways of achieving this are:
- arrangement for exhausts to be discharged well away from employees;
  - segregation of noisy processes to restrict the number of employees exposed to high noise levels, for example, engine testing in test rooms which only need to be entered occasionally; and
  - use of remote control or automated equipment to avoid the need for employees to spend long time near to machines.

## Active noise control

8. The principle of active noise control is the reduction or cancellation of one sound by the introduction of a second sound having equal amplitude but with reversed phase. The second sound is usually derived electronically from the original, with the aid of a microphone signal processing system and loud-speaker. There are considerable difficulties in designing and commissioning these systems and would normally be considered where other systems cannot yield satisfactory results.

## Enquiries

If you wish to enquire about this Guidance Notes or require advice on occupational safety and health matters, please contact the Occupational Safety and Health Branch of the Labour Department through:

Telephone : 2559 2297 (auto-recording service available outside office hours)

Fax : 2915 1410

E-mail : [enquiry@labour.gov.hk](mailto:enquiry@labour.gov.hk)

Information on the services offered by the Labour Department and on major labour legislation is also available on our website at <http://www.labour.gov.hk>.

For details on the services offered by the Occupational Safety and Health Council, please call 2739 9000.

## Complaints

If you have any complaints about unsafe workplaces and work practice, please call the Labour Department's occupational safety and health complaint hotline at 2542 2172. All complaints will be treated in the strictest confidence.











